

# Hoses and Connectors

MH, MM, PS, PLS, MP, TH and HC Series

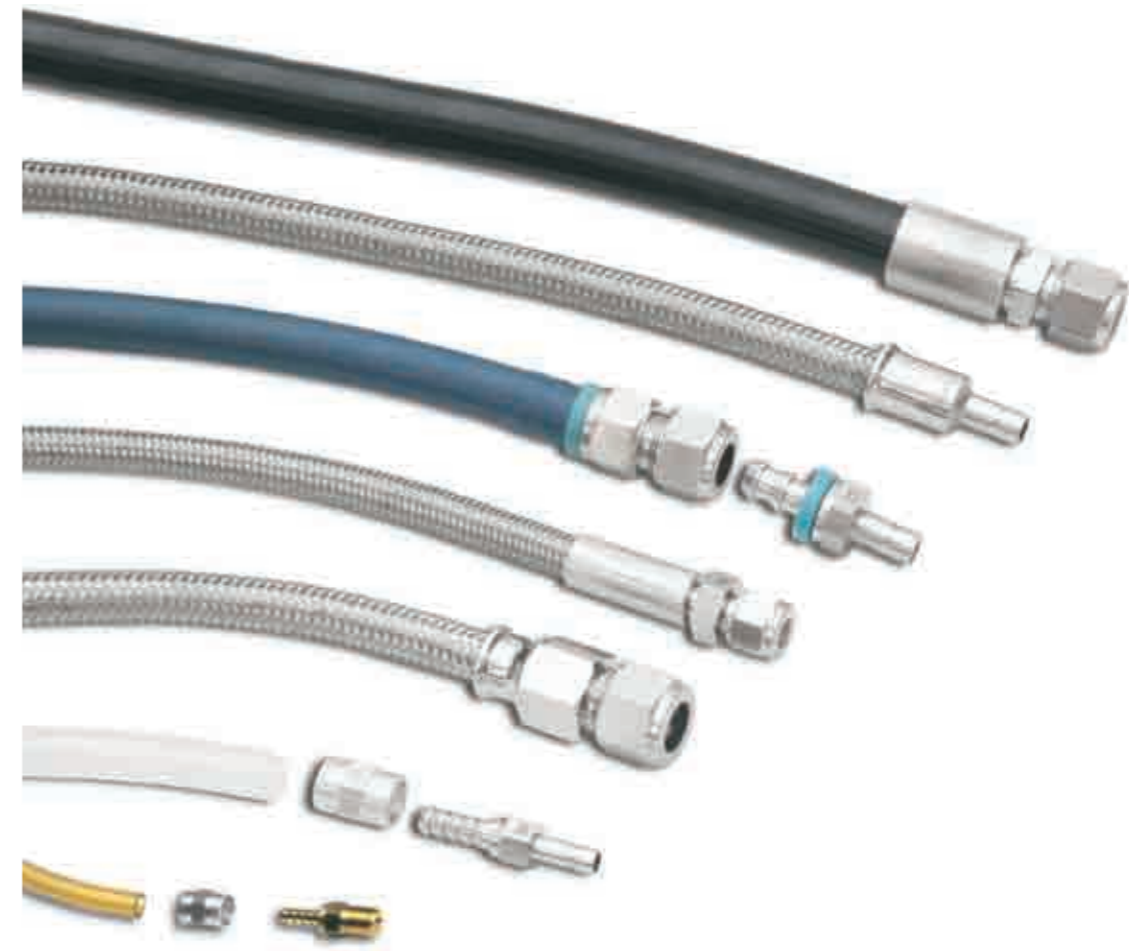

## **FITOK GmbH**

Sprendlinger Landstr. 115, 63069 Offenbach / Germany  
[www.fitokgmbh.de](http://www.fitokgmbh.de)  
[info@fitokgmbh.de](mailto:info@fitokgmbh.de)

## **FITOK INC.**

6100 Corporate Dr., Suite 588, Houston, Texas 77036, USA  
[www.fitokinc.com](http://www.fitokinc.com)  
[info@fitokinc.com](mailto:info@fitokinc.com)

## **FITOK Co., Ltd.**

Yingtailong Industrial Park, Shenzhen, 518109, China  
[www.fitok.com.cn](http://www.fitok.com.cn)  
[info@fitok.com.cn](mailto:info@fitok.com.cn)

FH0120409

**FITOK**  
Valves and Fittings

[www.fitokinc.com](http://www.fitokinc.com)

# Contents

Metal Flexible Hoses  
MH, MM Series



01

PTFE-lined, Stainless Steel Braided Hoses  
PS Series (High-pressure)



05

PTFE-lined, Stainless Steel Braided Hoses  
PLS Series (Low-pressure)



09

Multipurpose Push-on Hoses  
MP Series



13

Thermoplastic Hoses  
TH Series



17

Hose Connectors, Adapters and Sleeves  
HC Series



19

# Metal Flexible Hoses

## MH, MM Series

### Features

- ⦿ Core tube and fitting material: 316 stainless steel
- ⦿ Overbraid material: 304 stainless steel
- ⦿ Vacuum and positive pressure applications
- ⦿ Maximum working pressure: 4350 psig (300 bar)
- ⦿ Hose size: 1/4" to 2"
- ⦿ Working temperature: -325°F to 800°F (-200°C to 426°C)
- ⦿ End connections:
  - 1/8" to 1" thread
  - 3/16" to 1" and 6 mm to 22 mm tube fitting
- ⦿ Welded fitting-to-hose construction to ensure reliable seal
- ⦿ Standard and custom-length available

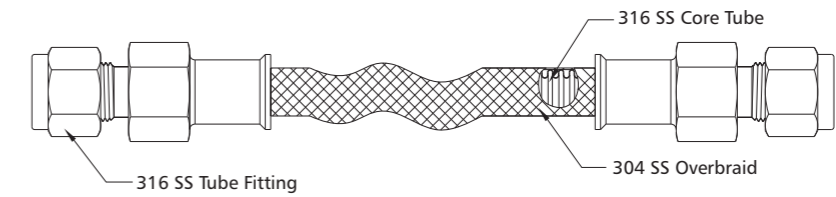

### Hose Technical Data (MH Series)

Nominal Hose Size	Inside Diameter	Min. Bend Radius		Temperature Range	Working Pressure at 70°F (20°C)	Burst Pressure at 70°F (20°C)	Hose Series
		Static	Dynamic				
in. (mm)	in. (mm)	in. (mm)	in. (mm)	°F (°C)	psig (bar)	psig (bar)	
1/4 (6.4)	0.28 (7.1)	2.25 (57.2)	10.0 (254)	-325 to 800 (-200 to 426)	3100 (213)	12400 (854)	MH4
3/8 (9.7)	0.42 (10.6)	3.00 (76.2)	12.0 (305)		2000 (137)	8000 (551)	MH6
1/2 (12.7)	0.53 (13.5)	4.50 (114)	16.0 (406)		1800 (124)	7200 (496)	MH8
3/4 (19.0)	0.80 (20.3)	6.00 (152)	17.0 (432)		1500 (103)	6000 (413)	MH12
1 (25.4)	1.03 (26.0)	6.75 (171)	20.0 (508)		1200 (82.6)	4800 (330)	MH16
1 1/4 (31.8)	1.30 (33.0)	8.86 (225)	23.0 (584)		950 (65.4)	3800 (261)	MH20
1 1/2 (38.1)	1.53 (38.9)	11.0 (280)	26.0 (660)		900 (62.0)	3600 (248)	MH24
2 (50.8)	2.05 (52.1)	13.8 (350)	32.0 (813)		500 (34.4)	2000 (137)	MH32

### Hose Technical Data (MM Series)

Nominal Hose Size	Inside Diameter	Min. Bend Radius		Temperature Range	Working Pressure at 70°F (20°C)	Burst Pressure at 70°F (20°C)	Hose Series
		Static	Dynamic				
in. (mm)	in. (mm)	in. (mm)	in. (mm)	°F (°C)	psig (bar)	psig (bar)	
1/4 (6.4)	0.25 (6.4)	0.75 (19.0)	4.33 (110)	-325 to 800 (-200 to 426)	1600 (110)	6400 (440)	MM4
3/8 (9.7)	0.38 (9.5)	0.87 (22.1)	5.91 (150)		1470 (101)	6000 (413)	MM6
1/2 (12.7)	0.50 (12.7)	1.04 (26.4)	6.50 (165)		1110 (76.4)	4500 (310)	MM8
3/4 (19.0)	0.75 (19.0)	1.61 (40.9)	8.86 (225)		860 (59.2)	3500 (241)	MM12
1 (25.4)	1.00 (25.4)	1.89 (48.0)	10.2 (259)		680 (46.8)	2680 (184)	MM16
1 1/4 (31.8)	1.25 (31.8)	2.16 (54.9)	11.8 (300)		680 (46.8)	2600 (179)	MM20
1 1/2 (38.1)	1.50 (38.1)	2.33 (59.2)	13.4 (340)		520 (35.8)	2200 (151)	MM24
2 (50.8)	2.00 (50.8)	3.10 (78.7)	15.4 (391)		450 (31.0)	1800 (124)	MM32

## Testing

Every FITOK metal flexible hose assembly is factory tested with helium to a maximum leak rate of  $1 \times 10^{-5}$  std cm<sup>3</sup>/s.

## Cleaning and Packaging

FITOK metal flexible hose components are cleaned in accordance with FITOK standard cleaning (FC-01) for general industrial procedures.

Shorter hoses are packed in cartons with suitable protective material, longer hoses are coiled, bagged and boxed or crated.

## Pressure vs. Temperature

### MH series

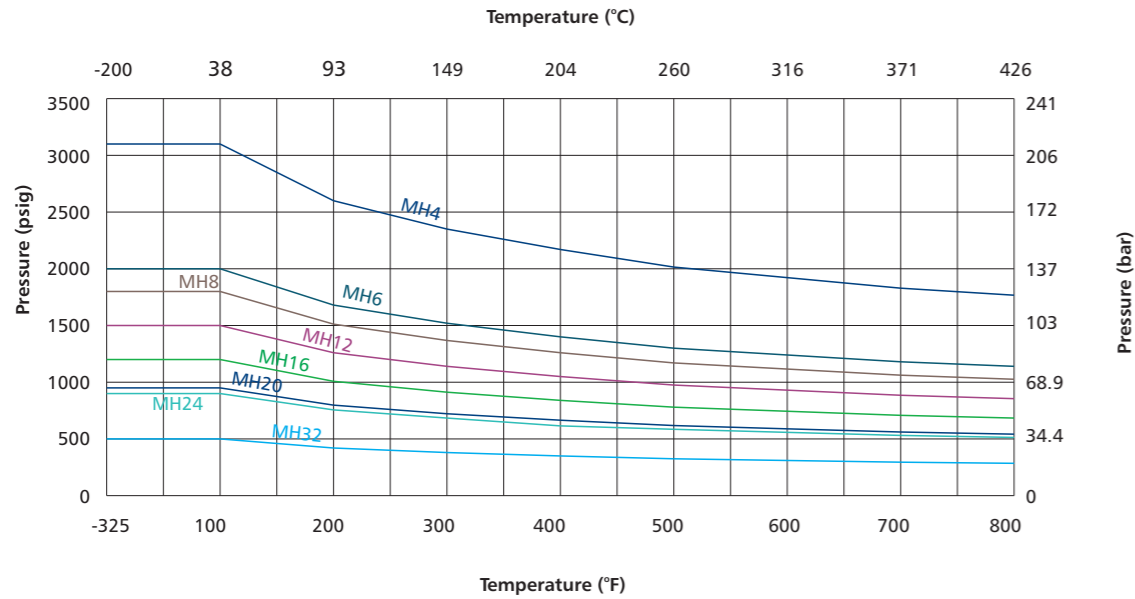

### MM series

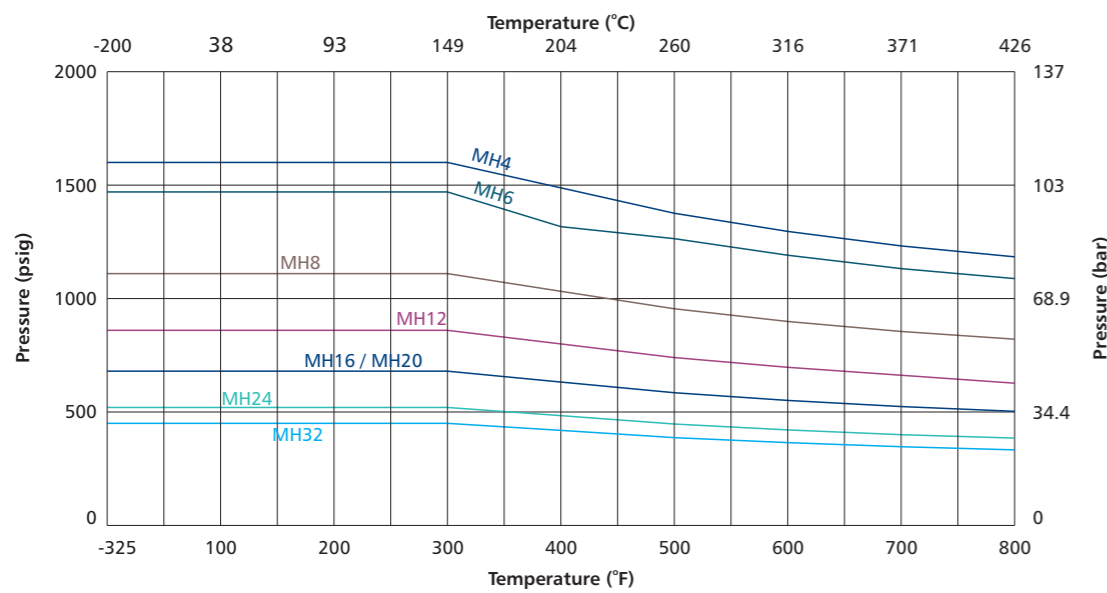

The working pressure of the hose selected must not exceed the maximum pressure, including any pressure spikes of the system. To determine actual working pressure ratings in accordance with pulsation, shock factors multiply by 0.5.

## Standard Assemblies

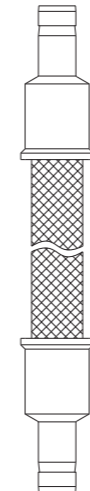

### Tube Fitting to Male NPT End

Nominal Hose Size in.	Tube Fitting Size in.	NPT Size in.	Hose Series	Overall length	Ordering Number	Minimum Inside Diameter in.(mm)	Maximum Outside Dimension in.(mm)
				in.(mm)			
1/4	1/4	1/4	MH4	12 (305)	SS-MH4-FL4-NS4-F12	0.19 (4.8)	0.95 (24.1)
			MM4	36 (914)	SS-MM4-FL4-NS4-F36	0.19 (4.8)	0.73 (18.6)
3/8	3/8	3/8	MH6	18 (457)	SS-MH6-FL6-NS6-F18	0.28 (7.1)	1.09 (27.7)
			MM6	36 (914)	SS-MM6-FL6-NS6-F36	0.28 (7.1)	0.80 (20.3)
1/2	1/2	1/2	MH8	18 (457)	SS-MH8-FL8-NS8-F18	0.41 (10.4)	1.23 (31.3)
			MM8	48 (1220)	SS-MM8-FL8-NS8-F48	0.41 (10.4)	1.02 (25.8)
3/4	3/4	3/4	MH12	18 (457)	SS-MH12-FL12-NS12-F18	0.66 (16.0)	1.74 (44.2)
			MM12	48 (1220)	SS-MM12-FL12-NS12-F48	0.66 (16.0)	1.32 (33.5)
1	1	1	MH16	24 (610)	SS-MH16-FL16-NS16-F24	0.88 (22.4)	2.03 (51.6)

### Tube Fitting End

Nominal Hose Size in.	Tube Fitting Size in.	Hose Series	Overall length	Ordering Number	Minimum Inside Diameter in.(mm)	Maximum Outside Dimension in.(mm)
			in.(mm)			
1/4	1/4	MH4	12 (305)	SS-MH4-FL4-F12	0.19 (4.8)	0.95 (24.1)
		MM4	36 (914)	SS-MM4-FL4-F36	0.19 (4.8)	0.65 (16.6)
3/8	3/8	MH6	18 (457)	SS-MH6-FL6-F18	0.28 (7.1)	1.09 (27.7)
		MM6	36 (914)	SS-MM6-FL6-F36	0.28 (7.1)	0.80 (20.3)
1/2	1/2	MH8	18 (457)	SS-MH8-FL8-F18	0.41 (10.4)	1.23 (31.3)
		MM8	48 (1220)	SS-MM8-FL8-F48	0.41 (10.4)	1.02 (25.8)
3/4	3/4	MH12	18 (457)	SS-MH12-FL12-F18	0.66 (16.0)	1.74 (44.2)
		MM12	48 (1220)	SS-MM12-FL12-F48	0.66 (16.0)	1.32 (33.5)
1	1	MH16	24 (610)	SS-MH16-FL16-F24	0.88 (22.4)	2.03 (51.6)

### Tube Adapter End

Nominal Hose Size in.	Tube Adapter Size in.	Hose Series	Overall length	Ordering Number	Minimum Inside Diameter in.(mm)	Maximum Outside Dimension in.(mm)
			in.(mm)			
1/4	1/4	MH4	12 (305)	SS-MH4-FT4-F12	0.16 (4.1)	0.75 (19.0)
		MM4	36 (914)	SS-MM4-FT4-F36	0.16 (4.1)	0.73 (18.6)
3/8	3/8	MH6	12 (305)	SS-MH6-FT6-F12	0.27 (6.9)	0.93 (23.6)
		MM6	36 (914)	SS-MM6-FT6-F36	0.27 (6.9)	0.93 (23.6)

1. All dimensions are for reference only and are subject to change. For dimensions not shown above, please contact the authorized representative or FITOK.
2. Sizes and types listed are standard. Other sizes and types are available upon request, refer to the ordering information.

## End Connections

### Tube Adapters

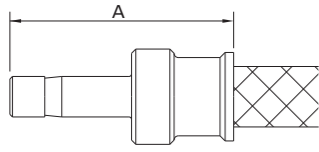

Tube Adapter Size	Nominal Hose Size	End Connection Designator	Dimensions		
			A	Minimum Inside Diameter	Maximum Outside Diameter
in.	in.		in. (mm)		
1/4	1/4	FT4	1.76 (44.7)	0.16 (4.1)	0.75 (19.0)
3/8	3/8	FT6	1.82 (46.2)	0.27 (6.9)	0.93 (23.6)
1/2	1/2	FT8	2.22 (56.4)	0.37 (9.4)	1.05 (26.7)
3/4	3/4	FT12	2.35 (59.7)	0.58 (14.7)	1.38 (35.1)
1	1	FT16	2.69 (68.3)	0.80 (20.3)	1.69 (42.9)
mm	in.		mm (in.)		
6	1/4	MT6	44.4 (1.75)	4.1 (0.16)	19.0 (0.75)
10	3/8	MT10	47.0 (1.85)	7.1 (0.28)	23.5 (0.93)
12	1/2	MT12	57.2 (2.25)	8.9 (0.35)	26.7 (1.05)

### Tube Fittings

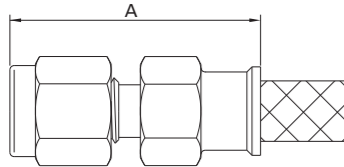

Tube Fitting Size	Nominal Hose Size	End Connection Designator	Dimensions		
			A	Minimum Inside Diameter	Maximum Outside Diameter
in.	in.		in. (mm)		
1/4	1/4	FL4	1.94 (49.3)	0.19 (4.8)	0.95 (24.1)
3/8	1/4	FL6	2.00 (50.8)	0.28 (7.1)	0.95 (24.1)
3/8	3/8	FL6	2.02 (51.3)	0.28 (7.1)	1.09 (27.7)
1/2	1/2	FL8	2.24 (56.9)	0.41 (10.4)	1.23 (31.3)
5/8	1/2	FL10	2.27 (57.7)	0.50 (12.7)	0.95 (24.1)
3/4	3/4	FL12	2.35 (59.7)	0.63 (16.0)	1.74 (44.2)
1	1	FL16	2.64 (67.1)	0.88 (22.4)	2.03 (51.6)
1 1/4	1 1/4	FL20	4.04 (103)	1.09 (27.7)	2.23 (58.9)
1 1/2	1 1/2	FL24	4.75 (121)	1.34 (34.0)	2.61 (66.3)
2	2	FL32	5.72 (145)	1.88 (47.8)	3.48 (88.4)
mm	in.		mm (in.)		
6	1/4	ML6	62.2 (2.45)	4.8 (0.19)	20.6 (0.81)
8	1/4	ML8	63.2 (2.49)	6.4 (0.25)	20.6 (0.81)
10	3/8	ML10	51.6 (2.03)	7.9 (0.31)	27.9 (1.10)
12	1/2	ML12	56.9 (2.24)	9.7 (0.38)	31.3 (1.23)

### Male FR Metal Gasket Face Seal Fittings Swivel

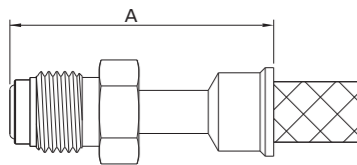

FR Size	Nominal Hose Size	End Connection Designator	Dimensions		
			A	Minimum Inside Diameter	Maximum Outside Diameter
in.	in.		in. (mm)		
1/4	1/4	SFR4	2.60 (66.0)	0.18 (4.6)	0.73 (18.4)
1/2	1/2	SFR8	2.83 (71.9)	0.40 (10.2)	1.09 (27.7)
3/4	3/4	SFR12	4.19 (106)	0.65 (16.5)	1.52 (38.7)
1	1	SFR16	4.80 (122)	0.87 (22.1)	1.89 (47.9)

## End Connections

### Female FR Metal Gasket Face Seal Fittings Swivel

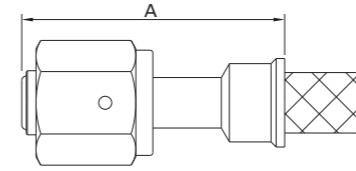

FR Size	Nominal Hose Size	End Connection Designator	Dimensions		
			A	Minimum Inside Diameter	Maximum Outside Diameter
in.	in.		in. (mm)		
1/4	1/4	SFFR4	2.00 (50.8)	0.18 (4.6)	0.87 (22.1)
1/2	1/2	SFFR8	2.16 (54.9)	0.40 (10.2)	1.23 (31.3)
3/4	3/4	SFFR12	4.19 (106)	0.65 (16.5)	1.74 (44.2)
1	1	SFFR16	4.80 (122)	0.87 (22.1)	2.03 (51.6)

### Female FO O-Ring Face Seal Fittings Swivel

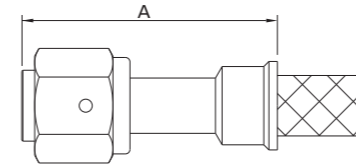

FO Size	Nominal Hose Size	End Connection Designator	Dimensions		
			A	Minimum Inside Diameter	Maximum Outside Diameter
in.	in.		in. (mm)		
1/4	1/4	SFFO4	2.11 (53.6)	0.18 (4.6)	0.80 (20.3)
1/2	1/2	SFFO8	2.14 (54.4)	0.40 (10.2)	1.16 (29.5)

### SAE 37° (JIC) Female Swivel

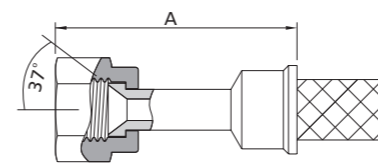

Swivel Size	Nominal Hose Size	End Connection Designator	Dimensions		
			A	Minimum Inside Diameter	Maximum Outside Diameter
in.	in.		in. (mm)		
1/4	1/4	SAN4	1.87 (47.5)	0.17 (4.3)	0.94 (23.9)
3/8	3/8	SAN6	1.98 (50.3)	0.28 (7.1)	1.09 (27.7)
1/2	1/2	SAN8	2.25 (57.2)	0.42 (10.7)	1.23 (31.3)

### Female Pipe Threads, NPT

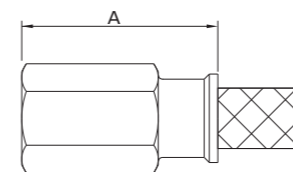

NPT Size	Nominal Hose Size	End Connection Designator	Dimensions		
			A	Minimum Inside Diameter	Maximum Outside Diameter
in.	in.		in. (mm)		
1/4	1/4	FNS4	1.81 (46.0)	0.28 (7.1)	0.94 (23.9)
3/8	3/8	FNS6	1.87 (47.5)	0.38 (9.7)	1.09 (27.7)
1/2	1/2	FNS8	2.18 (55.4)	0.47 (11.9)	1.23 (31.3)
3/4	3/4	FNS12	2.21 (56.1)	0.72 (18.3)	1.74 (44.2)

### Male Pipe Threads, NPT

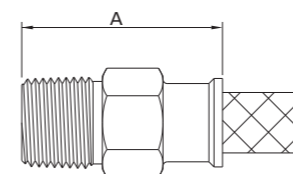

NPT Size	Nominal Hose Size	End Connection Designator	Dimensions		
			A	Minimum Inside Diameter	Maximum Outside Diameter
in.	in.		in. (mm)		
1/4	1/4	NS4	1.80 (45.7)	0.28 (7.1)	0.94 (23.9)
1/4	3/8	NS4	1.81 (46.0)	0.28 (7.1)	1.09 (27.7)
3/8	3/8	NS6	1.81 (46.0)	0.38 (9.7)	1.09 (27.7)
1/2	1/4	NS8	1.99 (50.6)	0.47 (11.9)	1.02 (25.8)
1/2	1/2	NS8	2.15 (54.6)	0.47 (11.9)	1.23 (31.3)
3/4	3/4	NS12	2.22 (56.4)	0.63 (16.0)	1.74 (44.2)
1	1	NS16	2.54 (64.5)	0.88 (22.4)	2.03 (51.6)
1 1/4	1 1/4	NS20	3.06 (77.7)	1.09 (27.7)	2.03 (51.6)
1 1/2	1 1/2	NS24	3.72 (94.5)	1.34 (34.0)	2.47 (62.6)
2	2	NS32	4.19 (106)	1.81 (46.0)	3.19 (81.0)

### Ordering Information

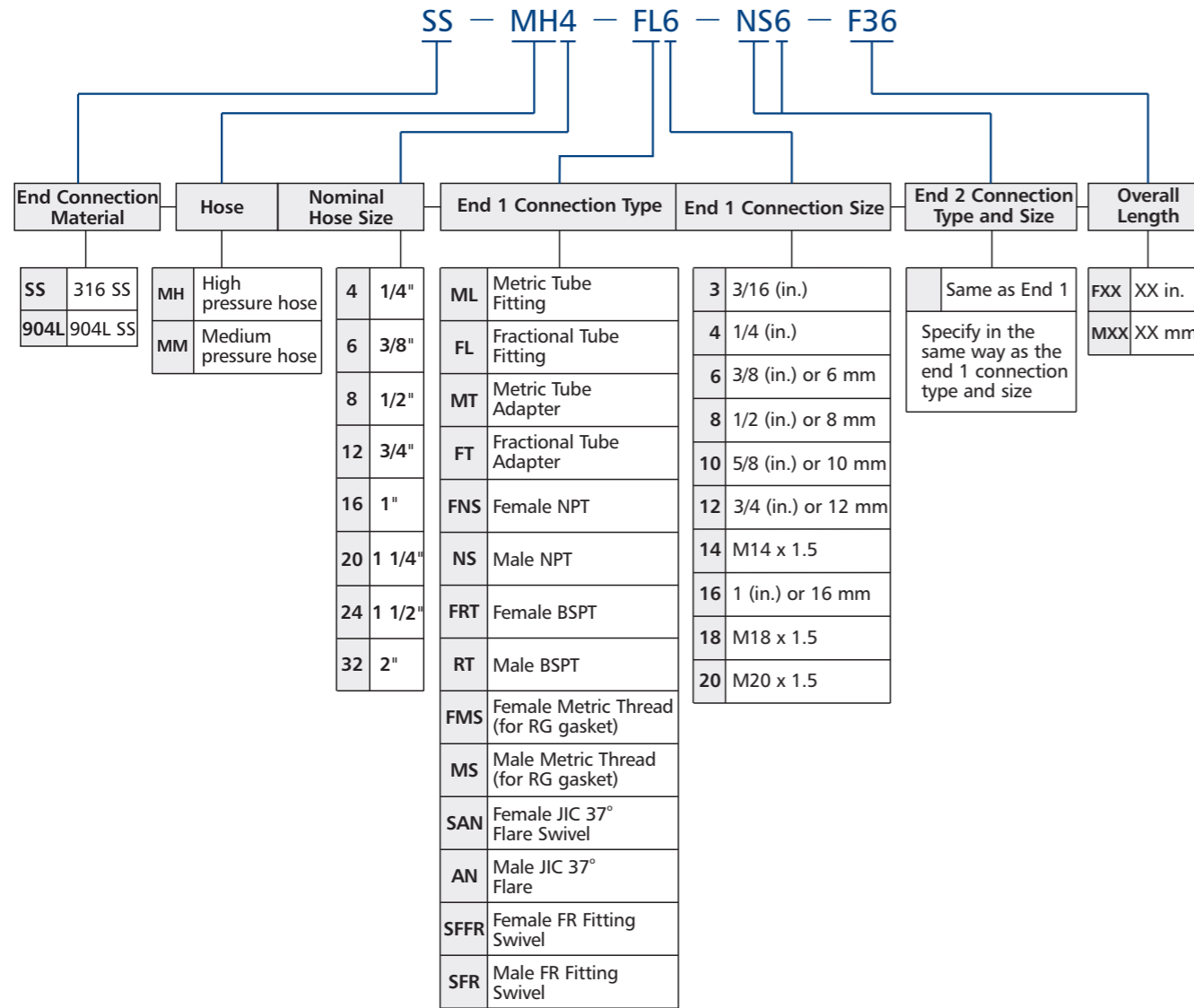

**Example: SS-MH4-FT6-M710**

SS: End connection material is 316 stainless steel.  
 MH4: MH series, hose size is 1/4".  
 FT6: End 1 connection type and size is 3/8" tube adapter.  
 End 2 connection type and size is 3/8" tube adapter.  
 M710: Overall length is 710 mm.

End 1 and end 2 follow the orders and regulations below:

- Metric Double Ferrules - Fractional Double Ferrules - Metric Tube Adapters - Fractional Tube Adapters - NPT Threads - BSPT Threads - BSPP Threads - SAE/MS Parallel Threads - 37° Flare - Others
- Put the sizes from the biggest down to the smallest if they are of the same type.
- Put the female before male if they are of the same type and size.

## PTFE-lined, Stainless Steel Braided Hoses

### PS Series (High-pressure)

#### Features

- Lightweight construction for easy handling and installation
- Core tube material: smooth virgin PTFE
- Overbraid material: 304 stainless steel
- Maximum working pressure: 3000 psig (206 bar)
- Hose size: 1/4" to 1"
- Working temperature: -65°F to 450°F (-53°C to 230°C)
- Standard and custom-length available

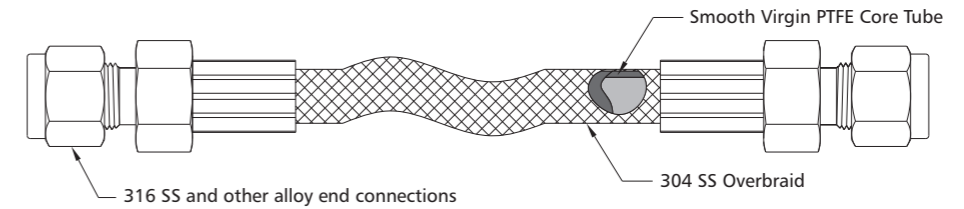

#### Hose Technical Data

Nominal Hose Size	Inside Diameter	Min. Inside Bend Radius		Temperature Range	Working Pressure at 70°F (20°C)	Burst Pressure at 70°F (20°C)
		Static	Dynamic			
in. (mm)	in. (mm)	in. (mm)	in. (mm)	°F (°C)	psig (bar)	psig (bar)
1/4 (6.4)	0.19 (4.8)	1.5 (38.1)	2.0 (50.8)	-65 to 450 (-53 to 230)	3000 (206)	12000 (826)
3/8 (9.5)	0.31 (7.9)	3.5 (88.9)	5.0 (127)		2500 (172)	10000 (689)
1/2 (12.7)	0.41 (10.3)	4.5 (114)	6.0 (152)		2000 (137)	8000 (551)
3/4 (19.0)	0.63 (15.9)	6.0 (152)	7.5 (190)		1500 (103)	6000 (413)
1 (25.4)	0.88 (22.2)	9.0 (229)	11.3 (287)		1000 (68)	4000 (275)

### Pressure vs. Temperature

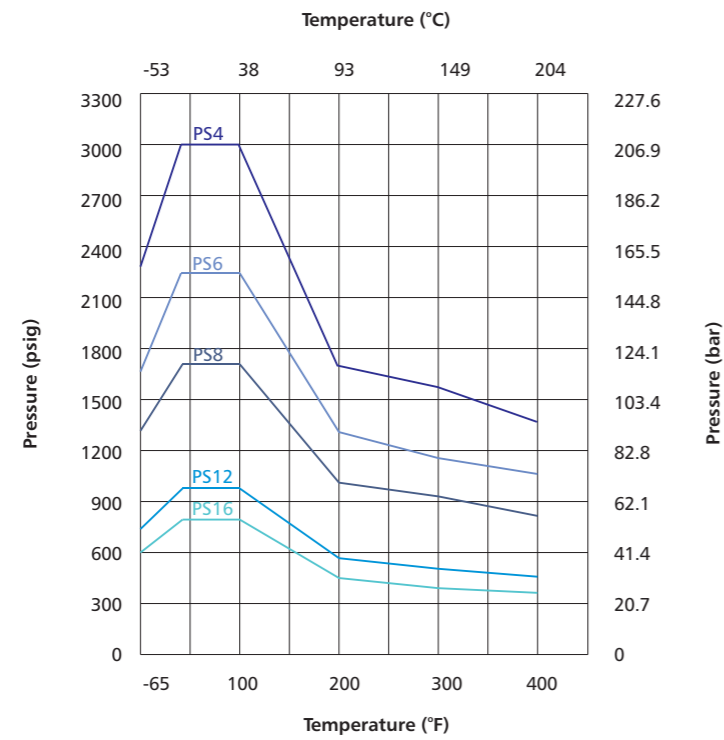

### Testing

Every FITOK PTFE-lined hose assembly is factory tested with pure water at 1.5 times the maximum working pressure.

### Cleaning and Packaging

FITOK PTFE-lined hose components are cleaned in accordance with FITOK standard cleaning (FC-01) for general industrial procedures.

Shorter hoses are packed in cartons with suitable protective material, longer hoses are coiled, bagged and boxed or crated.

### PTFE-lined Hose Standard Assemblies

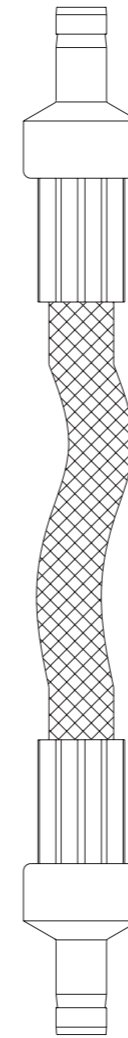

#### Tube Adapters

Nominal Hose Size	Tube Adapter Size	Overall Length	Ordering Number	Minimum Inside Diameter	Maximum Outside Diameter
in.	in.	in.(mm)		in.(mm)	in.(mm)
1/4	1/4	6.0 (153)	SS-PS4-FT4-F6	0.16 (4.1)	0.54 (13.7)
		12.0 (305)	SS-PS4-FT4-F12		
		18.0 (458)	SS-PS4-FT4-F18		
		24.0 (610)	SS-PS4-FT4-F24		
		36.0 (915)	SS-PS4-FT4-F36		
		48.0 (1220)	SS-PS4-FT4-F48		
		60.0 (1530)	SS-PS4-FT4-F60		
		72.0 (1829)	SS-PS4-FT4-F72		
		120.0 (3050)	SS-PS4-FT4-F120		
3/8	3/8	12.0 (305)	SS-PS6-FT6-F12	0.27 (6.9)	0.73 (18.5)
		18.0 (458)	SS-PS6-FT6-F18		
		24.0 (610)	SS-PS6-FT6-F24		
		36.0 (915)	SS-PS6-FT6-F36		
		48.0 (1220)	SS-PS6-FT6-F48		
		60.0 (1530)	SS-PS6-FT6-F60		
		72.0 (1829)	SS-PS6-FT6-F72		
		96.0 (2439)	SS-PS6-FT6-F96		
		120.0 (3050)	SS-PS6-FT6-F120		
1/2	1/2	12.0 (305)	SS-PS8-FT8-F12	0.36 (9.1)	0.86 (21.8)
		24.0 (610)	SS-PS8-FT8-F24		
		36.0 (915)	SS-PS8-FT8-F36		
		48.0 (1220)	SS-PS8-FT8-F48		
		60.0 (1530)	SS-PS8-FT8-F60		
		72.0 (1829)	SS-PS8-FT8-F72		
3/4	3/4	24.0 (610)	SS-PS12-FT12-F24	0.53 (13.5)	1.04 (26.4)
		36.0 (915)	SS-PS12-FT12-F36		
1	1	36.0 (915)	SS-PS16-FT16-F36	0.80 (20.3)	1.36 (34.5)
		48.0 (1220)	SS-PS16-FT16-F48		
in.	mm	in.(mm)	—	in.(mm)	in.(mm)
1/4	6	12.0 (305)	SS-PS4-MT6-F12	0.16 (4.1)	0.54 (13.7)
		24.0 (610)	SS-PS4-MT6-F24		
		36.0 (915)	SS-PS4-MT6-F36		
1/2	12	24.0 (610)	SS-PS8-MT12-F24	0.33 (8.4)	0.86 (21.8)
		36.0 (915)	SS-PS8-MT12-F36		

1. All dimensions are for reference only and are subject to change. For dimensions not shown above, please contact the authorized representative or FITOK.
2. Sizes and types listed are standard. Other sizes and types are available on request, refer to the ordering information.

Ordering Information

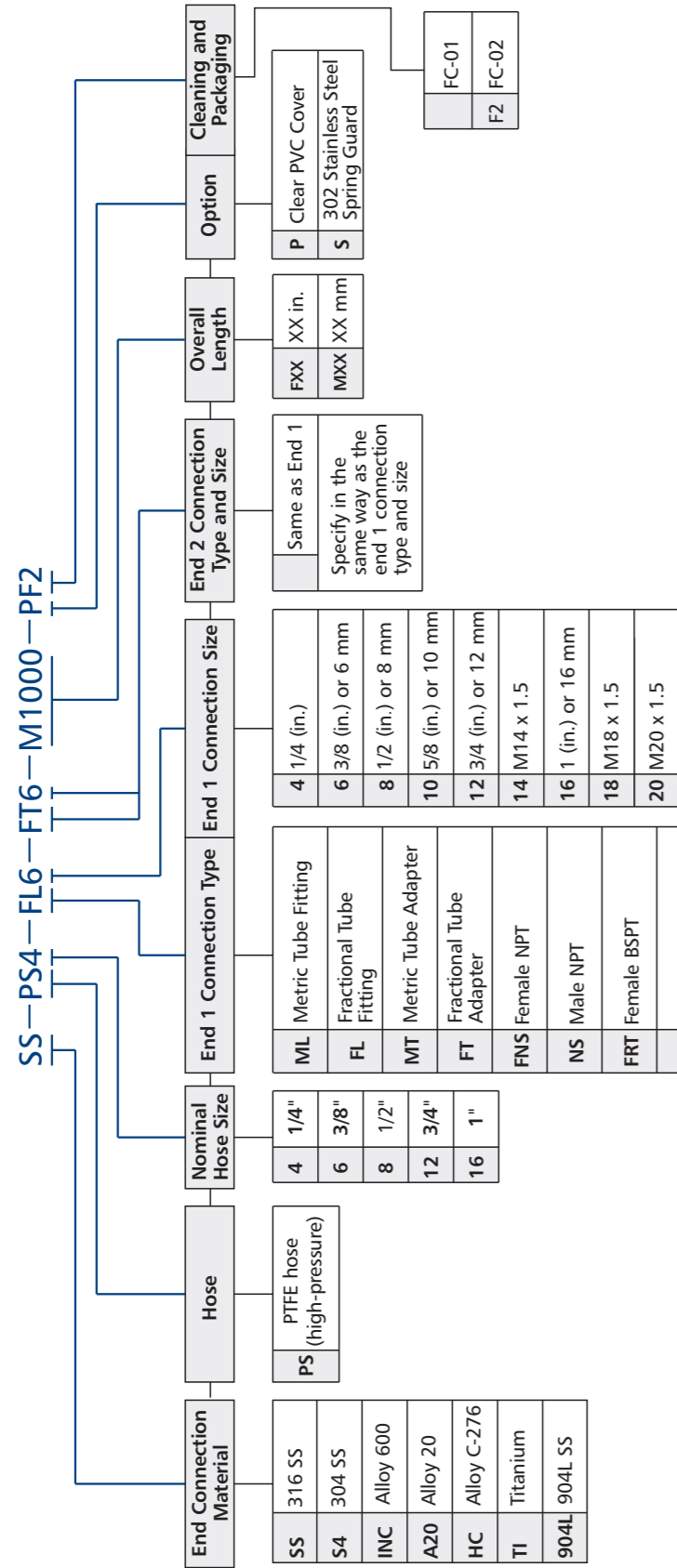

1. Options and accessories do not change hose technical data. Hose operating parameters must be considered when selecting a cover.

2. Lucid PVC cover resists abrasion.

3. 302 stainless steel spring guard covers entire hose to protect against kinking and abrasion.

4. To order a hose assembly with special cleaning and packaging (FC-02), following ASTM G93 Level C, add -F2 as a suffix to the ordering number.

Example: **SS-PS4-FT4-F24-F2**.

End 1 and end 2 follow the orders and regulations below:

- 1. Metric Double Ferrules - Fractional Double Ferrules - Metric Tube Adapters - Fractional Tube Adapters - NPT Threads - BSPT Threads - BSPP Threads - SAE/IMS Parallel Threads - 37° Flare - Others

2. Put the sizes from the biggest down to the smallest if they are of the same type.

3. Put the female before male if they are of the same type and size.

Example: **SS-PS4-SAN4-M500**

SS: End connection material is 316 stainless steel.

PS4: PS series, hose inside diameter is 3/16".

SAN4: End 1 connection type and size is 1/4" fitting size, female JIC 37° flare swivel.

End 2 connection type and size is 1/4" fitting size, female JIC 37° flare swivel.

M500: Overall length is 500 mm.

# PTFE-lined, Stainless Steel Braided Hoses

## PLS Series (Low-pressure)

### Features

- Lightweight construction for easy handling and installation
- Core tube material: smooth virgin PTFE
- Overbraid material: 304 stainless steel
- Maximum working pressure: 1100 psig (76 bar)
- Hose size: 1/4" to 1"
- Working temperature: -65°F to 400°F (-53°C to 204°C)
- Standard and custom-length available

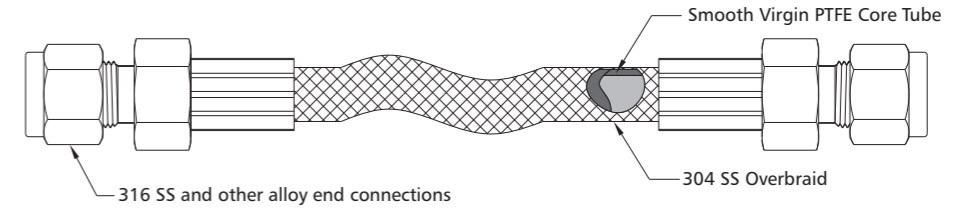

### Hose Technical Data

Nominal Hose Size	Inside Diameter	Min. Inside Bend Radius		Temperature Range	Working Pressure at 70°F (20°C)	Burst Pressure at 70°F (20°C)
		Static	Dynamic			
in. (mm)	in. (mm)	in. (mm)	in. (mm)	°F (°C)	psig (bar)	psig (bar)
1/4 (6.4)	0.19 (4.8)	1.5 (38.1)	2.0 (50.8)	-65 to 450 (-53 to 230)	1100 (75)	4400 (303)
3/8 (9.5)	0.31 (7.9)	3.5 (88.9)	5.0 (127)		900 (62)	3600 (248)
1/2 (12.7)	0.41 (10.3)	4.5 (114)	6.0 (152)		650 (44)	2600 (179)
3/4 (19.0)	0.63 (15.9)	6.0 (152)	7.5 (190)		550 (37)	2200 (151)
1 (25.4)	0.88 (22.2)	9.0 (229)	11.3 (287)		400 (27)	1600 (110)

### Pressure vs. Temperature

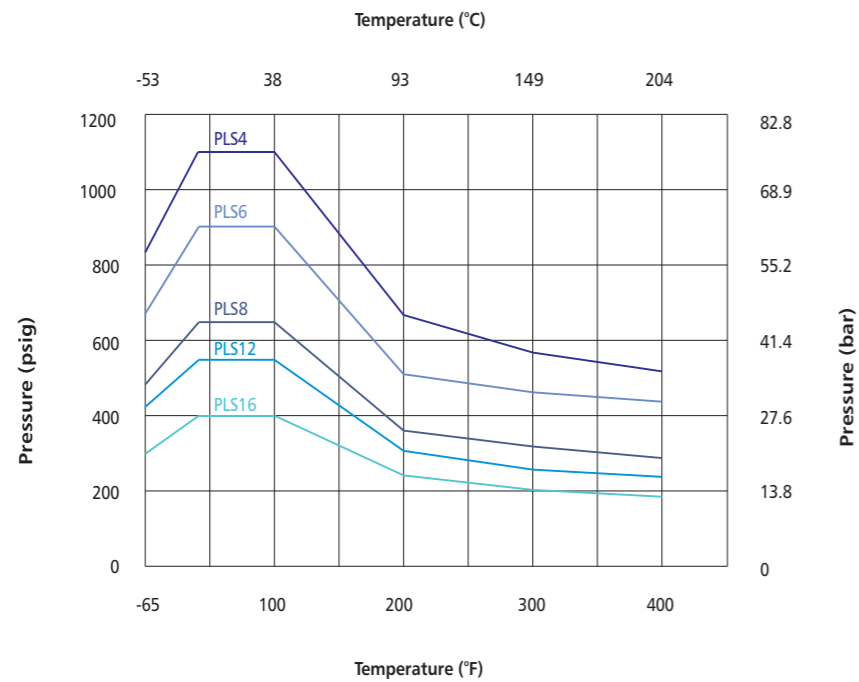

### Testing

Every FITOK PTFE-lined hose assembly is factory tested with pure water at 1.5 times the maximum working pressure.

### Cleaning and Packaging

FITOK PTFE-lined hose components are cleaned in accordance with FITOK standard cleaning (FC-01) for general industrial procedures.

Shorter hoses are packed in cartons with suitable protective material, longer hoses are coiled, bagged and boxed or crated.

### PTFE-lined Hose Standard Assemblies

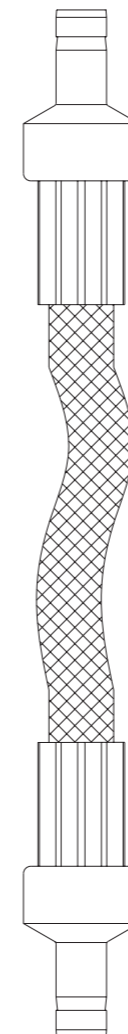

#### Tube Adapters

Nominal Hose Size	Tube Adapter Size	Overall Length	Ordering Number	Minimum Inside Diameter	Maximum Outside Diameter
in.	in.	in.(mm)		in.(mm)	in.(mm)
1/4	1/4	6.0 (153)	SS-PLS4-FT4-F6	0.16 (4.1)	0.54 (13.7)
		12.0 (305)	SS-PLS4-FT4-F12		
		18.0 (458)	SS-PLS4-FT4-F18		
		24.0 (610)	SS-PLS4-FT4-F24		
		36.0 (915)	SS-PLS4-FT4-F36		
		48.0 (1220)	SS-PLS4-FT4-F48		
		60.0 (1530)	SS-PLS4-FT4-F60		
		72.0 (1829)	SS-PLS4-FT4-F72		
120.0 (3050)	SS-PLS4-FT4-F120				
3/8	3/8	12.0 (305)	SS-PLS6-FT6-F12	0.27 (6.9)	0.73 (18.5)
		18.0 (458)	SS-PLS6-FT6-F18		
		24.0 (610)	SS-PLS6-FT6-F24		
		36.0 (915)	SS-PLS6-FT6-F36		
		48.0 (1220)	SS-PLS6-FT6-F48		
		60.0 (1530)	SS-PLS6-FT6-F60		
		72.0 (1829)	SS-PLS6-FT6-F72		
		96.0 (2439)	SS-PLS6-FT6-F96		
120.0 (3050)	SS-PLS6-FT6-F120				
1/2	1/2	12.0 (305)	SS-PLS8-FT8-F12	0.36 (9.1)	0.86 (21.8)
		24.0 (610)	SS-PLS8-FT8-F24		
		36.0 (915)	SS-PLS8-FT8-F36		
		48.0 (1220)	SS-PLS8-FT8-F48		
		60.0 (1530)	SS-PLS8-FT8-F60		
3/4	3/4	24.0 (610)	SS-PLS12-FT12-F24	0.53 (13.5)	1.04 (26.4)
		36.0 (915)	SS-PLS12-FT12-F36		
1	1	36.0 (915)	SS-PLS16-FT16-F36	0.80 (20.3)	1.36 (34.5)
		48.0 (1220)	SS-PLS16-FT16-F48		
in.	mm	in.(mm)	—	in.(mm)	in.(mm)
1/4	6	12.0 (305)	SS-PLS4-MT6-F12	0.16 (4.1)	0.54 (13.7)
		24.0 (610)	SS-PLS4-MT6-F24		
		36.0 (915)	SS-PLS4-MT6-F36		
1/2	12	24.0 (610)	SS-PLS8-MT12-F24	0.33 (8.4)	0.86 (21.8)
		36.0 (915)	SS-PLS8-MT12-F36		

1. All dimensions are for reference only and are subject to change. For dimensions not shown above, please contact the authorized representative or FITOK.
2. Sizes and types listed are standard. Other sizes and types are available on request, refer to the ordering information.



Ordering Information

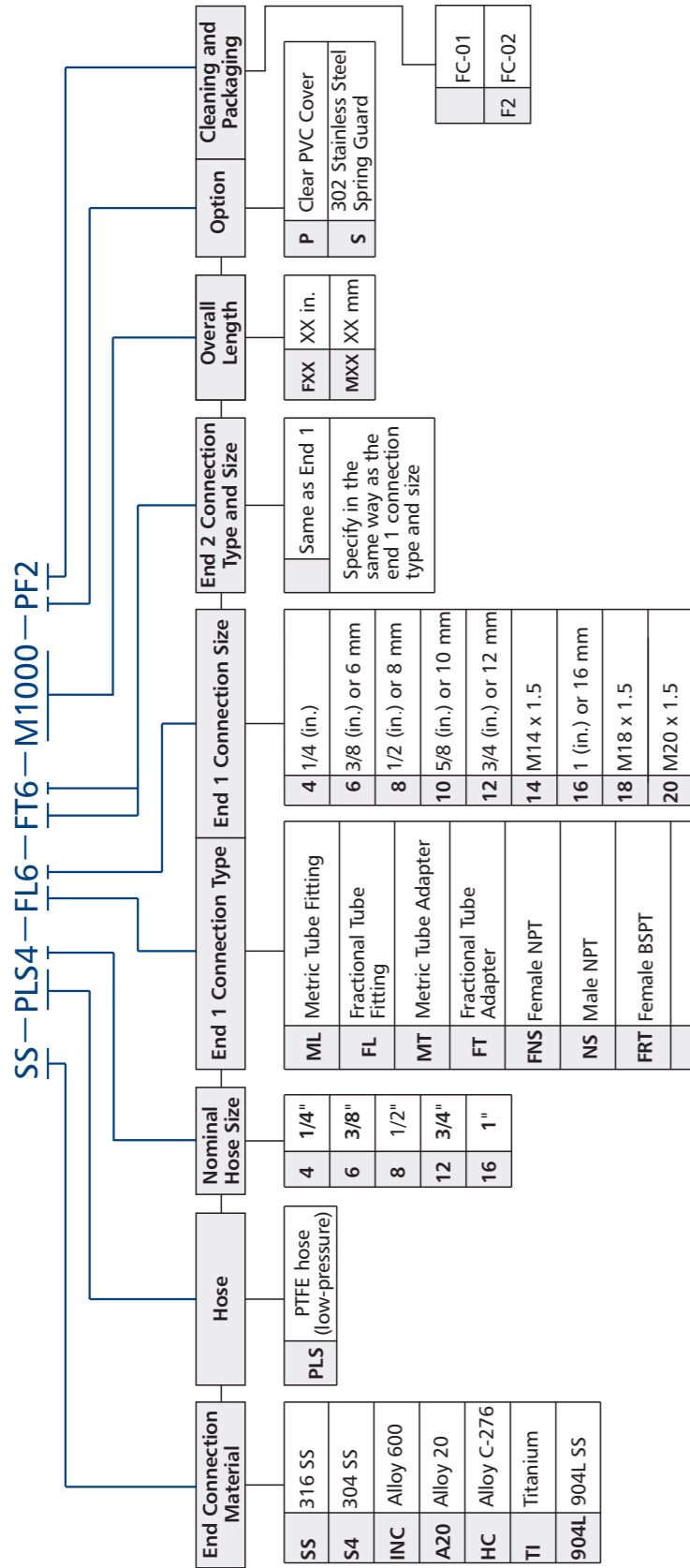

- Options and accessories do not change hose technical data. Hose operating parameters must be considered when selecting a cover.
  - Lucid PVC cover resists abrasion.
  - 302 stainless steel spring guard covers entire hose to protect against kinking and abrasion.
  - To order a hose assembly with special cleaning and packaging (FC-02), following ASTM G93 level C, add -F2 as a suffix to the ordering number.  
Example: **SS-PLS4-FT4-F24-F2**.
- End 1 and end 2 follow the orders and regulations below:  
 1. Metric Double Ferrules - Fractional Double Ferrules - Metric Tube Adapters - Fractional Tube Adapters - NPT Threads - BSPT Threads - BSPP Threads - SAE/MS Parallel Threads - 37° Flare - Others  
 2. Put the sizes from the biggest down to the smallest if they are of the same type.  
 3. Put the female before male if they are of the same type and size.

Example: **SS-PLS4-SAN4-M500**  
 SS: End connection material is 316 stainless steel.  
 PLS4: PLS series, hose inside diameter is 3/16".  
 SAN4: End 1 connection type and size is 1/4" fitting size, female JIC 37° flare swivel.  
 End 2 connection type and size is 1/4" fitting size, female JIC 37° flare swivel.  
 M500: Overall length is 500 mm.

# Multipurpose Push-on Hoses

## MP Series

### Features

- Cover: weatherproof, abrasion withstanding and oil-resistant synthetic rubber
- Reinforcement: single-braid high-strength synthetic fiber woven for maximum strength and end connection retention
- Core tube: highly oil-resistant rubber
- Hose colors: blue, black, green, gray, red and yellow
- Maximum working pressure: 300 psig (20.7 bar)
- Hose size: 1/4" to 3/4"
- Working temperature: -40°F to 190°F (-40°C to 88°C)
- End connection materials: stainless steel and brass
- End connections reusable
- Custom-length available

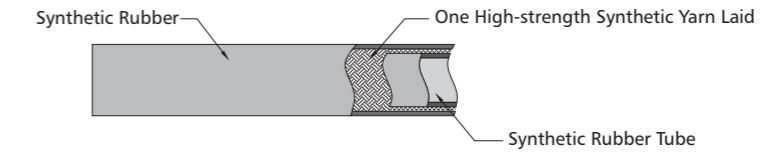

### Hose Technical Data

Nominal Hose Size	Inside Diameter	Min. Inside Bend Radius	Temperature Range	Working Pressure at -40 to 70°F (-40 to 20°C)	Min. Burst Pressure at 70°F (20°C)
in. (mm)	in. (mm)	in. (mm)	°F(°C)	psig (bar)	psig (bar)
1/4 (6.4)	0.26 (6.6)	2.50 (63.5)	-40 to 200 (-40 to 93)	300 (20.6)	1200 (82.7)
3/8 (9.5)	0.39 (9.9)	3.00 (76.2)			
1/2 (12.7)	0.50 (12.7)	5.00 (127)			
3/4 (19.0)	0.76 (19.3)	7.00 (178)			

### Pressure vs. Temperature

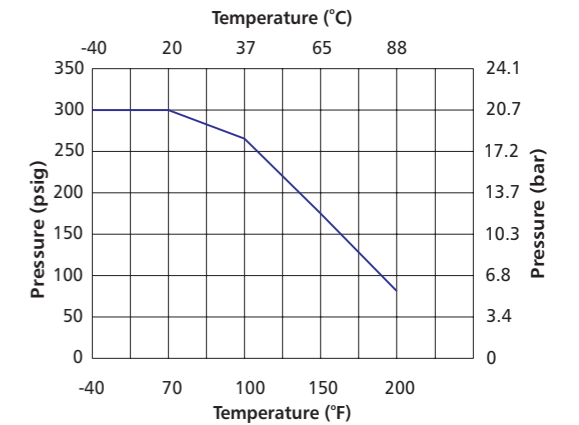

### Testing

Every FITOK multipurpose push-on hose assembly is factory tested with pure water at 1.5 times the maximum working pressure.

### Cleaning and Packaging

FITOK multipurpose push-on hose components are cleaned in accordance with FITOK standard cleaning (FC-01) for general industrial procedures. Shorter hoses are packed in cartons with suitable protective material, longer hoses are coiled, bagged and boxed or crated.

### Caution:

- Do not reuse hose.

## Multipurpose Push-on Hose End Connections

### Tube Fittings

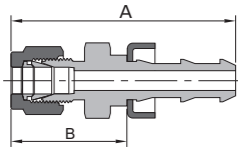

Nominal Hose Size	Tube Fitting Size	Basic Ordering Number	Dimensions, in.(mm)			
			A	B	Minimum Inside Diameter	Maximum Outside Diameter
in.	in.					
1/4	1/4	-MP4-FL4	1.97 (50.0)	1.21 (30.7)	0.16 (4.1)	0.67 (17.0)
3/8	3/8	-MP6-FL6	2.11 (53.6)	1.24 (31.5)	0.27 (6.9)	0.87 (22.1)
1/2	1/2	-MP8-FL8	2.47 (62.7)	1.42 (36.1)	0.37 (9.5)	1.02 (25.8)

### Tube Adapters

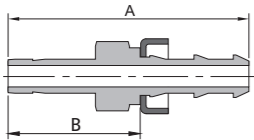

Nominal Hose Size	Tube Adapter Size	Basic Ordering Number	Dimensions, in.(mm)			
			A	B	Minimum Inside Diameter	Maximum Outside Diameter
in.	in.					
1/4	1/4	-MP4-FT4	1.93 (49.0)	1.17 (29.7)	0.15 (3.8)	0.67 (17.0)
3/8	3/8	-MP6-FT6	2.03 (51.6)	1.16 (29.5)	0.24 (6.1)	0.83 (21.1)
1/2	1/2	-MP8-FT8	2.47 (62.7)	1.42 (36.1)	0.34 (8.7)	0.98 (24.9)
3/4	3/4	-MP12-FT12	3.14 (79.8)	1.48 (37.6)	0.57 (14.5)	1.23 (31.3)
in.	mm		mm(in.)			
1/4	6	-MP4-MT6	49.0 (1.93)	29.7 (1.17)	3.8 (0.15)	17.0 (0.67)
1/4	8	-MP4-MT8	48.8 (1.92)	29.5 (1.16)	4.1 (0.16)	17.0 (0.67)
3/8	8	-MP6-MT8	52.1 (2.05)	30.0 (1.18)	5.6 (0.22)	21.1 (0.83)
3/8	10	-MP6-MT10	51.6 (2.03)	29.5 (1.16)	6.9 (0.27)	21.1 (0.83)
1/2	12	-MP8-MT12	62.7 (2.47)	36.1 (1.42)	8.1 (0.32)	24.9 (0.98)
3/4	18	-MP12-MT18	79.8 (3.14)	37.3 (1.47)	8.6 (0.34)	31.3 (1.23)

### Male NPT

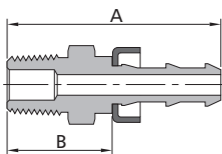

Nominal Hose Size	NPT Size	Basic Ordering Number	Dimensions, in.(mm)			
			A	B	Minimum Inside Diameter	Maximum Outside Diameter
in.						
1/4	1/4	-MP4-NS4	1.68 (42.7)	0.92 (23.4)	0.16 (4.1)	0.67 (17.0)
3/8	1/4	-MP6-NS4	1.80 (45.7)	0.93 (23.6)	0.27 (6.9)	0.83 (21.1)
3/8	3/8	-MP6-NS6	1.80 (45.7)	0.93 (23.6)	0.27 (6.9)	0.83 (21.1)
1/2	1/2	-MP8-NS8	2.19 (55.6)	1.14 (29.0)	0.37 (9.5)	1.02 (25.9)
3/4	3/4	-MP12-NS12	2.81 (71.4)	1.14 (29.0)	0.61 (15.6)	1.31 (33.3)

### Male BSPT

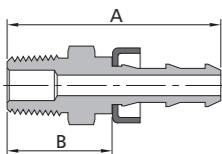

Nominal Hose Size	BSPT Size	Basic Ordering Number	Dimensions, in.(mm)			
			A	B	Minimum Inside Diameter	Maximum Outside Diameter
in.						
1/4	1/4	-MP4-RT4	1.68 (42.7)	0.92 (23.4)	0.16 (4.1)	0.67 (17.0)
3/8	1/4	-MP6-RT4	1.80 (45.7)	0.93 (23.6)	0.27 (6.9)	0.83 (21.1)
3/8	3/8	-MP6-RT6	1.80 (45.7)	0.93 (23.6)	0.27 (6.9)	0.83 (21.1)
1/2	1/2	-MP8-RT8	2.19 (55.6)	1.14 (29.0)	0.37 (9.5)	1.02 (25.9)
3/4	3/4	-MP12-RT12	2.81 (71.4)	1.14 (29.0)	0.61 (15.6)	1.31 (33.3)

### Unions

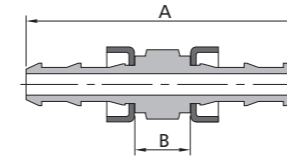

Nominal Hose Size	Basic Ordering Number	Dimensions, in.(mm)			
		A	B	Minimum Inside Diameter	Maximum Outside Diameter
in.					
1/4	-MP4-4	2.07 (52.6)	0.43 (11.0)	0.16 (4.1)	0.67 (17.0)
3/8	-MP6-6	2.25 (57.2)	0.40 (10.1)	0.27 (6.9)	0.83 (21.1)
1/2	-MP8-8	2.61 (66.3)	0.40 (10.1)	0.37 (9.5)	0.96 (24.5)
3/4	-MP12-12	3.85 (97.8)	0.47 (12.0)	0.61 (15.6)	1.23 (31.3)

## Hose Ordering Information

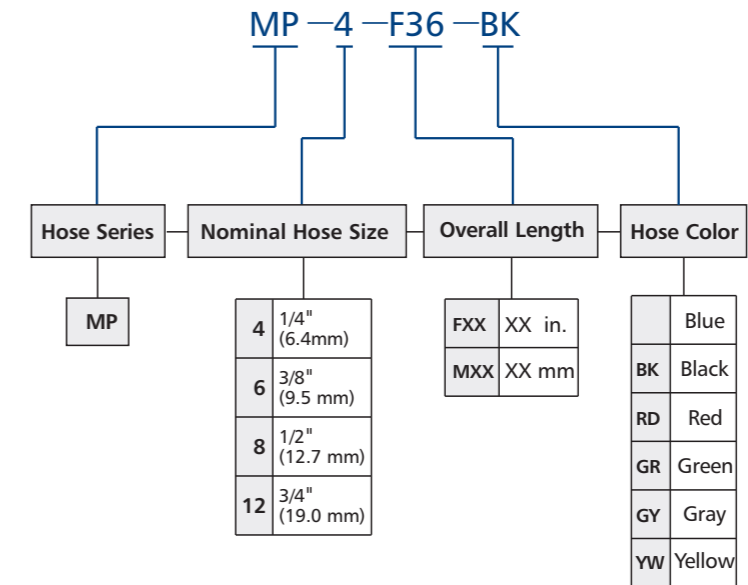

Example: **MP-8-F60-BK**  
**MP:** Hose series  
**8:** Hose size is 1/2".  
**F60:** Overall length is 60".  
**BK:** Hose color is black.

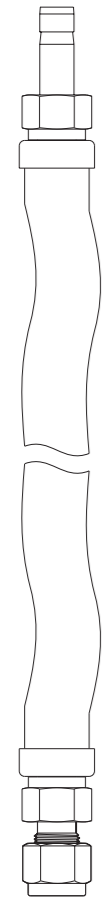

Ordering Information

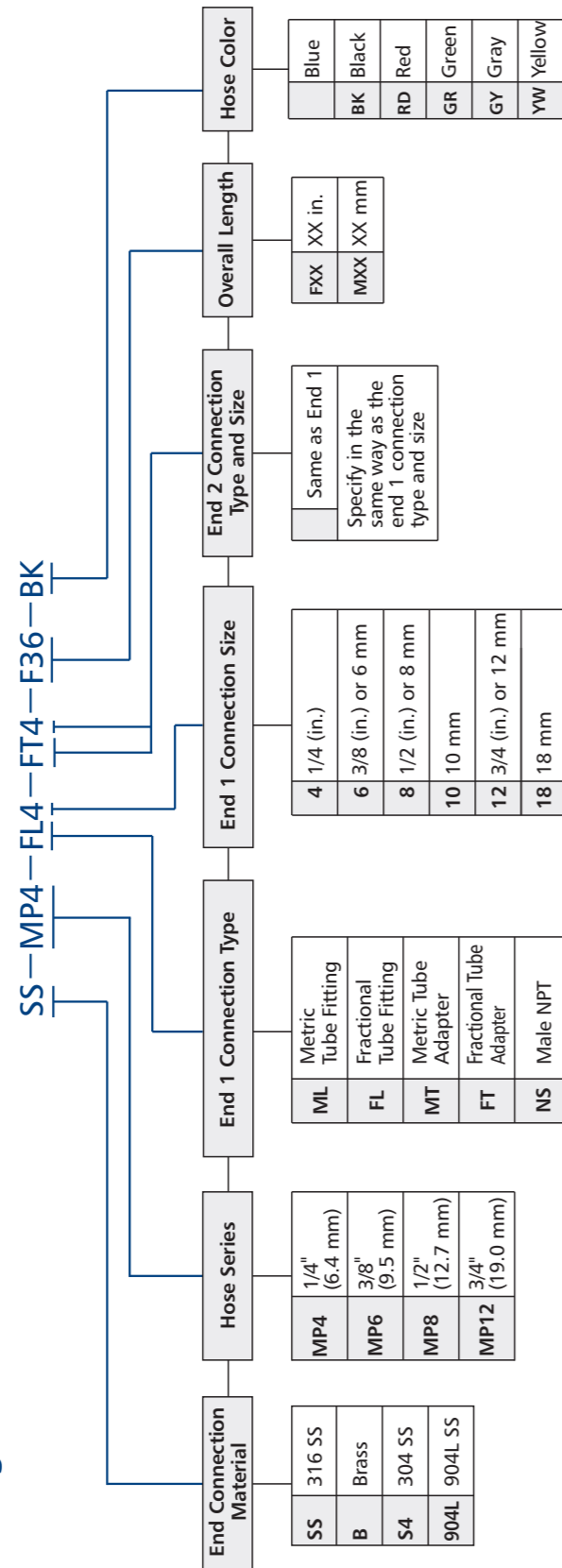

Example: **SS-MP4-FT4-F28-BK**

**SS:** End connection material is 316 stainless steel.

**MP4:** MP series, hose size is 1/4".

**FT4:** End 1 connection type and size is 1/4" tube adapter.

End 2 connection type and size is 1/4" tube adapter.

**F28:** Overall length is 28".

**BK:** Hose color is black.

End 1 and end 2 follow the orders and regulations below:

1. Metric Double Ferrules - Fractional Double Ferrules - Metric Tube Adapters - Fractional Tube Adapters - NPT Threads - BSPT Threads - BSPP Threads - SAE/MS Parallel Threads - 37° Flare - Others
2. Put the sizes from the biggest down to the smallest if they are of the same type.
3. Put the female before male if they are of the same type and size.

# Thermoplastic Hoses

## TH Series

### Features

- Polyurethane cover: resists oil, weather and abrasion
- Reinforcement: double-braid high-strength synthetic fiber
- Core tube: nylon
- Maximum working pressure: 5000 psig (345 bar)
- Hose size: 3/16" to 1"
- Working temperature: -40°F to 200°F (-40°C to 93°C)
- End connections: 1/4" to 1" thread, 1/4" to 1" and 6 mm to 22 mm tube fitting
- End connection materials: stainless steel, brass and carbon steel
- Custom-length available

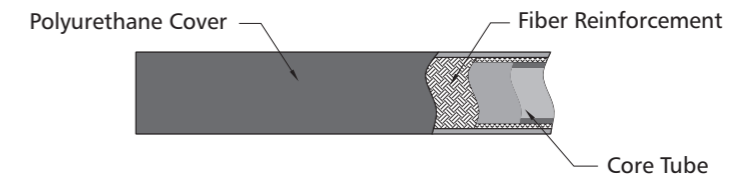

### Technical Data

#### Thermoplastic Hydraulic Hose (SAE 100R7)

Nominal Hose Size	Hose Series	Min. Inside Bend Radius	Inside Diameter	Temperature Range	Working Pressure at 70°F (20°C)	Min. Burst Pressure at 70°F (20°C)	Specification
in. (mm)		in. (mm)	in. (mm)	°F (°C)	psig (bar)	psig (bar)	
3/16 (4.8)	TH3	1.58 (40)	0.19 (4.8)	-40 to 200 (-40 to 93)	3000 (207)	12000 (828)	SAE J517 100R7
1/4 (6.4)	TH4	1.97 (50)	0.25 (6.4)		2750 (189)	11000 (758)	
5/16 (8.0)	TH5	2.36 (60)	0.31 (7.9)		2500 (173)	10000 (689)	
3/8 (9.6)	TH6	2.95 (75)	0.38 (9.8)		2250 (155)	9000 (620)	
1/2 (12.7)	TH8	3.74 (95)	0.50 (12.7)		2000 (137)	8000 (551)	

#### Thermoplastic Hydraulic Hose (SAE 100R8)

Nominal Hose Size	Hose Series	Min. Inside Bend Radius	Inside Diameter	Temperature Range	Working Pressure at 70°F (20°C)	Min. Burst Pressure at 70°F (20°C)	Specification
in. (mm)		in. (mm)	in. (mm)	°F (°C)	psig (bar)	psig (bar)	
3/16 (4.8)	TH3	2.00 (50.8)	0.19 (4.8)	-40 to 200 (-40 to 93)	5000 (344)	20000 (1378)	SAE J517 100R8
1/4 (6.4)	TH4	2.00 (50.8)	0.25 (6.4)		5000 (344)	20000 (1378)	
3/8 (9.6)	TH6	2.50 (63.5)	0.38 (9.8)		4000 (275)	16000 (1102)	
1/2 (12.7)	TH8	4.00 (102)	0.50 (12.7)		3500 (241)	14000 (964)	
3/4 (19.0)	TH12	6.50 (165)	0.75 (19.0)		2250 (155)	9000 (620)	
					2000 (137)	8000 (551)	
1 (25.4)	TH16	10.0 (254)	1.00 (25.4)				

### Testing

Every FITOK thermoplastic hose assembly is factory tested with pure water at 1.5 times the maximum working pressure.

### Cleaning and Packaging

FITOK thermoplastic hose components are cleaned in accordance with FITOK standard cleaning (FC-01) for general industrial procedures. Shorter hoses are packed in cartons with suitable protective material, longer hoses are coiled, bagged and boxed or crated.



Ordering Information

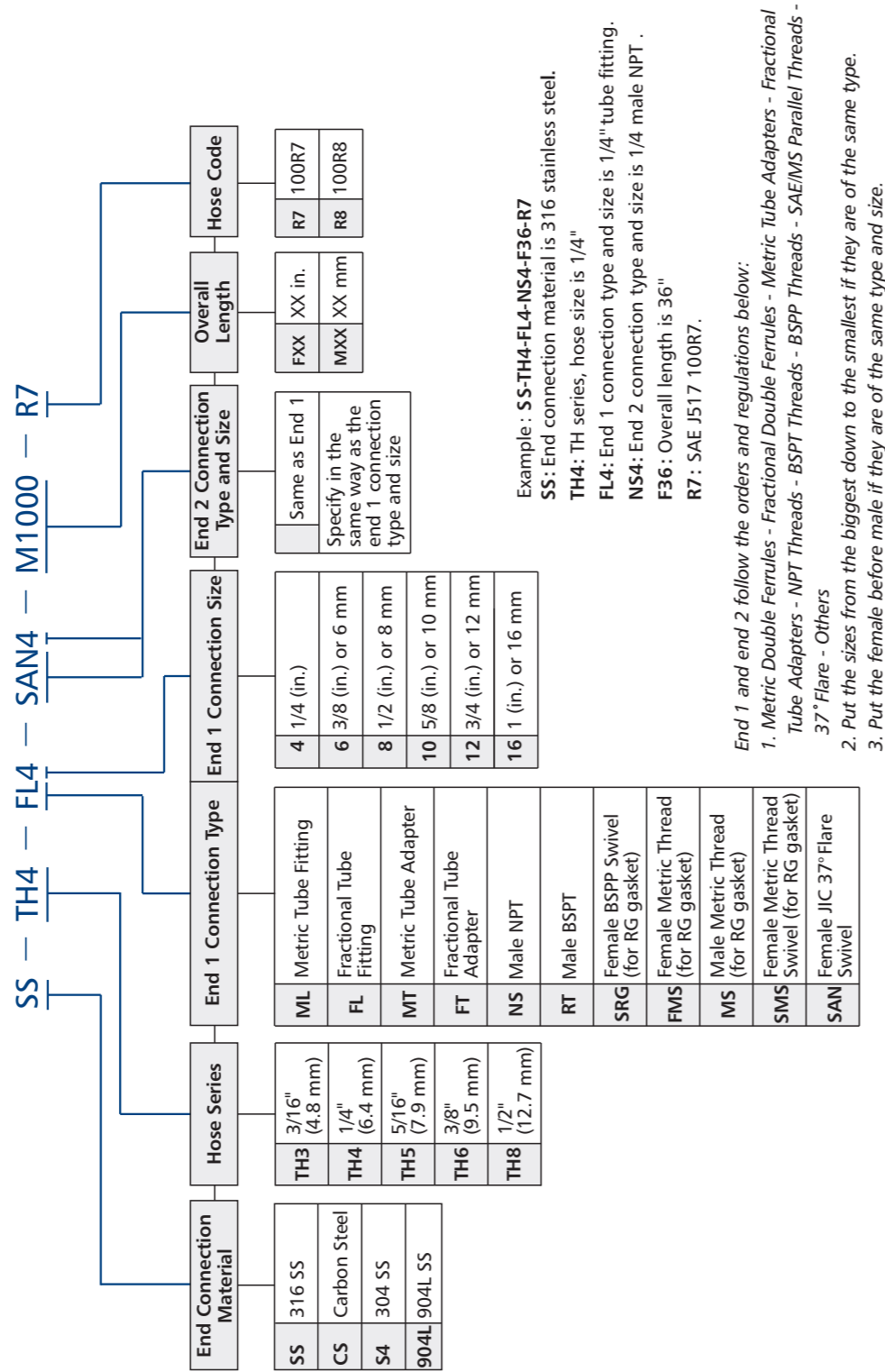

# Hose Connectors and Sleeves

## HC Series

### Features

- Used to connect soft plastic or rubber tubing.
- Working pressures and working temperatures are wider than those of the connected hoses.
- Stainless steel or brass is available.
- Shank design holds tubing inside diameter securely.
- Hose connectors are reusable.



### Hose Connectors

#### Tube Fittings

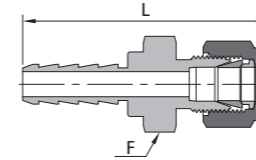

Hose ID	Tube Size	Basic Ordering Number	Dimensions		
			Minimum Inside Diameter	F	L
in.	in.		in.(mm)	in.	in.(mm)
1/8	1/8	-HC-F2-FL2	0.08 (2.0)	7/16	1.42 (36.1)
1/4	1/8	-HC-F4-FL2	0.09 (2.3)	7/16	1.81 (46.0)
	1/4	-HC-F4-FL4	0.19 (4.8)	9/16	1.92 (48.8)
3/8	1/4	-HC-F6-FL4	0.19 (4.8)	9/16	1.99 (50.6)
	3/8	-HC-F6-FL6	0.28 (7.1)	3/4	2.06 (52.3)
1/2	1/2	-HC-F8-FL8	0.38 (9.7)	7/8	2.24 (56.9)
mm	mm		mm (in.)	mm	mm (in.)
6	6	-HC-M6-ML6	4.8 (0.19)	14	49.5 (1.95)
8	8	-HC-M8-ML8	6.4 (0.25)	16	49.8 (1.96)
	10	-HC-M8-ML10	6.4 (0.25)	18	51.6 (2.03)
10	10	-HC-M10-ML10	7.9 (0.31)	19	52.3 (2.06)
12	12	-HC-M12-ML12	9.7 (0.38)	22	57.4 (2.26)

#### Tube Adapters

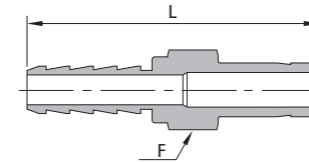

Hose ID	Tube Size	Basic Ordering Number	Dimensions			
			Minimum Inside Diameter	F	L	
in.	in.		in.(mm)	in.	in.(mm)	
1/8	1/8	-HC-F2-FT2	0.08 (2.0)	5/16	1.37 (34.8)	
	1/4	-HC-F2-FT4	0.09 (2.3)	3/8	1.47 (37.3)	
1/4	1/4	-HC-F4-FT4	0.19 (4.8)	7/16	1.86 (47.2)	
	3/8	-HC-F4-FT6	0.19 (4.8)	7/16	1.92 (48.8)	
5/16	1/4	-HC-F5-FT4	0.19 (4.8)	7/16	1.94 (49.3)	
	3/8	1/4	-HC-F6-FT4	0.19 (4.8)	9/16	1.94 (49.3)
		3/8	-HC-F6-FT6	0.28 (7.1)	9/16	2.00 (50.8)
1/2	1/2	-HC-F6-FT8	0.30 (7.6)	5/8	2.26 (57.4)	
	3/8	3/8	-HC-F8-FT6	0.28 (7.1)	11/16	2.07 (52.6)
		1/2	-HC-F8-FT8	0.38 (9.7)	11/16	2.33 (59.2)
3/4	3/4	-HC-F12-FT12	0.63 (16.0)	13/16	2.50 (63.5)	
1	1	-HC-F16-FT16	0.80 (20.3)	1 3/8	3.03 (77.0)	

Male NPT

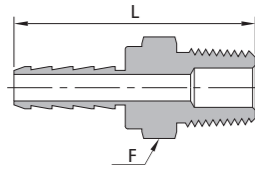

Hose ID	NPT Size	Basic Ordering Number	Dimensions		
			Minimum Inside Diameter	F	L
in.			in.(mm)	in.	in.(mm)
1/8	1/8	-HC-F2-NS2	0.08 (2.0)	7/16	1.08 (27.4)
	1/4	-HC-F2-NS4	0.08 (2.0)	9/16	1.26 (32.0)
3/16	1/8	-HC-F3-NS2	0.13 (3.3)	7/16	1.27 (32.2)
	1/4	-HC-F3-NS4	0.13 (3.3)	9/16	1.45 (36.8)
1/4	1/8	-HC-F4-NS2	0.19 (4.8)	7/16	1.47 (37.3)
	1/4	-HC-F4-NS4	0.19 (4.8)	9/16	1.65 (41.9)
	3/8	-HC-F4-NS6	0.19 (4.8)	11/16	1.66 (42.2)
	1/2	-HC-F4-NS8	0.19 (4.8)	7/8	1.85 (47.0)
5/16	1/8	-HC-F5-NS2	0.19 (4.8)	7/16	1.55 (39.4)
	1/4	-HC-F5-NS4	0.19 (4.8)	9/16	1.73 (43.9)
	3/8	-HC-F5-NS6	0.19 (4.8)	11/16	1.74 (44.2)
	1/2	-HC-F5-NS8	0.19 (4.8)	7/8	1.96 (49.8)
3/8	1/4	-HC-F6-NS4	0.30 (7.6)	9/16	1.73 (43.9)
	3/8	-HC-F6-NS6	0.30 (7.6)	11/16	1.74 (44.2)
	1/2	-HC-F6-NS8	0.30 (7.6)	7/8	1.96 (49.8)
1/2	1/4	-HC-F8-NS4	0.30 (7.6)	11/16	1.80 (45.7)
	3/8	-HC-F8-NS6	0.38 (9.7)	11/16	1.81 (46.0)
	1/2	-HC-F8-NS8	0.38 (9.7)	7/8	2.03 (51.6)
5/8	3/8	-HC-F10-NS6	0.38 (9.7)	1 1/16	1.88 (47.8)
	1/2	-HC-F10-NS8	0.47 (11.9)	1 1/16	2.07 (52.6)
	3/4	-HC-F10-NS12	0.50 (12.7)	1 1/16	2.07 (52.6)
3/4	1/2	-HC-F12-NS8	0.47 (11.9)	1 1/16	2.14 (54.4)
	3/4	-HC-F12-NS12	0.63 (16.0)	1 1/16	2.14 (54.4)
	1	-HC-F12-NS16	0.63 (16.0)	1 3/8	2.43 (61.7)
1	3/4	-HC-F16-NS12	0.63 (16.0)	1 3/8	2.38 (60.5)
	1	-HC-F16-NS16	0.88 (22.4)	1 3/8	2.57 (65.3)

Male BSPT

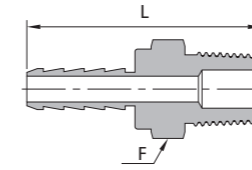

Hose ID	BSPT Size	Basic Ordering Number	Dimensions		
			Minimum Inside Diameter	F	L
in.			in.(mm)	in.	in.(mm)
1/8	1/8	-HC-F2-RT2	0.08 (2.0)	7/16	1.28 (32.5)
	1/4	-HC-F2-RT4	0.08 (2.0)	9/16	1.40 (35.5)
3/16	1/8	-HC-F3-RT2	0.13 (3.3)	7/16	1.40 (35.5)
	1/4	-HC-F3-RT4	0.13 (3.3)	9/16	1.58 (40.1)
1/4	1/8	-HC-F4-RT2	0.19 (4.8)	7/16	1.47 (37.3)
	1/4	-HC-F4-RT4	0.19 (4.8)	9/16	1.65 (41.9)
	3/8	-HC-F4-RT6	0.19 (4.8)	11/16	1.66 (42.2)
	1/2	-HC-F4-RT8	0.19 (4.8)	7/8	1.90 (48.3)
5/16	1/8	-HC-F5-RT2	0.19 (4.8)	7/16	1.67 (42.4)
	1/4	-HC-F5-RT4	0.19 (4.8)	9/16	1.86 (47.2)
	3/8	-HC-F5-RT6	0.19 (4.8)	11/16	1.87 (47.5)
	1/2	-HC-F5-RT8	0.19 (4.8)	7/8	2.10 (53.3)
3/8	1/4	-HC-F6-RT4	0.30 (7.6)	9/16	1.73 (43.9)
	3/8	-HC-F6-RT6	0.30 (7.6)	11/16	1.74 (44.2)
	1/2	-HC-F6-RT8	0.30 (7.6)	7/8	1.96 (49.8)
1/2	1/4	-HC-F8-RT4	0.30 (7.6)	11/16	1.80 (45.7)
	3/8	-HC-F8-RT6	0.38 (9.7)	11/16	1.81 (46.0)
	1/2	-HC-F8-RT8	0.38 (9.7)	7/8	2.03 (51.6)
5/8	3/8	-HC-F10-RT6	0.38 (9.7)	1 1/16	1.88 (47.8)
	1/2	-HC-F10-RT8	0.47 (11.9)	1 1/16	2.07 (52.6)
	3/4	-HC-F10-RT12	0.50 (12.7)	1 1/16	2.07 (52.6)
3/4	1/2	-HC-F12-RT8	0.47 (11.9)	1 1/16	2.14 (54.4)
	3/4	-HC-F12-RT12	0.63 (16.0)	1 1/16	2.14 (54.4)
	1	-HC-F12-RT16	0.63 (16.0)	1 3/8	2.43 (61.7)
1	3/4	-HC-F16-RT12	0.63 (16.0)	1 3/8	2.38 (60.5)
	1	-HC-F16-RT16	0.88 (22.4)	1 3/8	2.57 (65.3)

Female NPT

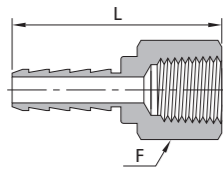

Hose ID	NPT Size	Basic Ordering Number	Dimensions		
			Minimum Inside Diameter	F	L
in.			in.(mm)	in.	in.(mm)
1/8	1/8	-HC-F2-FNS2	0.08 (2.0)	9/16	1.11 (28.2)
	1/4	-HC-F2-FNS4	0.08 (2.0)	3/4	1.26 (32.0)
3/16	1/8	-HC-F3-FNS2	0.13 (3.3)	9/16	1.29 (32.8)
	1/4	-HC-F3-FNS4	0.13 (3.3)	3/4	1.44 (36.6)
1/4	1/8	-HC-F4-FNS2	0.19 (4.8)	9/16	1.47 (37.3)
	1/4	-HC-F4-FNS4	0.19 (4.8)	3/4	1.64 (41.7)
	3/8	-HC-F4-FNS6	0.19 (4.8)	7/8	1.71 (43.4)
5/16	1/4	-HC-F5-FNS4	0.19 (4.8)	3/4	1.73 (43.9)
	3/8	-HC-F5-FNS6	0.19 (4.8)	7/8	1.82 (46.2)
3/8	1/4	-HC-F6-FNS4	0.30 (7.6)	3/4	1.69 (42.9)
	3/8	-HC-F6-FNS6	0.30 (7.6)	7/8	1.78 (45.2)
	1/2	-HC-F6-FNS8	0.30 (7.6)	1 1/16	2.03 (51.6)
1/2	1/2	-HC-F8-FNS8	0.38 (9.7)	1 1/16	2.13 (54.1)

Female BSPT

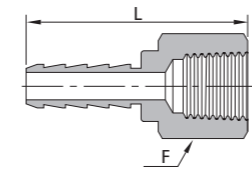

Hose ID	BSPT Size	Basic Ordering Number	Dimensions		
			Minimum Inside Diameter	F	L
in.			in.(mm)	in.	in.(mm)
1/8	1/8	-HC-F2-FRT2	0.08 (2.0)	9/16	1.11 (28.2)
	1/4	-HC-F2-FRT4	0.08 (2.0)	3/4	1.26 (32.0)
3/16	1/8	-HC-F3-FRT2	0.13 (3.3)	9/16	1.29 (32.8)
	1/4	-HC-F3-FRT4	0.13 (3.3)	3/4	1.44 (36.6)
1/4	1/8	-HC-F4-FRT2	0.19 (4.8)	9/16	1.47 (37.3)
	1/4	-HC-F4-FRT4	0.19 (4.8)	3/4	1.64 (41.7)
	3/8	-HC-F4-FRT6	0.19 (4.8)	7/8	1.71 (43.4)
5/16	1/4	-HC-F5-FRT4	0.19 (4.8)	3/4	1.73 (43.9)
	3/8	-HC-F5-FRT6	0.19 (4.8)	7/8	1.82 (46.2)
3/8	1/4	-HC-F6-FRT4	0.30 (7.6)	3/4	1.69 (42.9)
	3/8	-HC-F6-FRT6	0.30 (7.6)	7/8	1.78 (45.2)
	1/2	-HC-F6-FRT8	0.30 (7.6)	1 1/16	2.03 (51.6)
1/2	1/2	-HC-F8-FRT8	0.38 (9.7)	1 1/16	2.13 (54.1)

Metric Thread

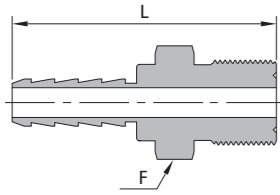

Hose ID	Thread Size	Basic Ordering Number	Dimensions		
			Minimum Inside Diameter	F	L
mm	in.		in.(mm)	mm	in.(mm)
6	M10 x 1	-HC-M6-MS10	4.3 (0.17)	12	39.6 (1.54)
	M12 x 1.5	-HC-M6-MS12	4.3 (0.17)	14	40.4 (1.59)
	M14 x 1.5	-HC-M6-MS14	4.3 (0.17)	15	42.2 (1.66)
8	M14 x 1.5	-HC-M8-MS14	4.8 (0.19)	15	44.2 (1.74)
	M16 x 1.5	-HC-M8-MS16	4.8 (0.19)	18	46.2 (1.82)
10	M16 x 1.5	-HC-M10-MS16	7.9 (0.31)	18	46.2 (1.82)
	M18 x 1.5	-HC-M10-MS18	7.9 (0.31)	19	47.2 (1.86)
12	M20 x 1.5	-HC-M12-MS20	8.9 (0.35)	22	50.3 (1.98)
	M22 x 1.5	-HC-M12-MS22	8.9 (0.35)	24	52.8 (2.08)

Hose Connector Sleeves

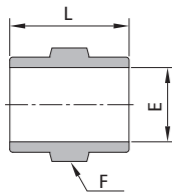

Hose ID	Hose OD	Ordering Number	Dimension, in. (mm)		
			E	F	L
in.	in.				
1/8	1/4	AL-HC-F2-F4	0.26 (6.6)	3/8	0.40 (10.2)
1/4	3/8	AL-HC-F4-F6	0.41 (10.4)	9/16	0.79 (20.1)
1/4	7/16	AL-HC-F4-F7	0.46 (11.7)	5/8	0.79 (20.1)
1/4	1/2	AL-HC-F4-F8	0.52 (13.2)	11/16	0.79 (20.1)
5/16	7/16	AL-HC-F5-F7	0.48 (12.2)	5/8	0.87 (22.1)
3/8	1/2	AL-HC-F6-F8	0.55 (14.0)	11/16	0.87 (22.1)
3/8	9/16	AL-HC-F6-F9	0.61 (15.5)	3/4	0.87 (22.1)
7/16	5/8	AL-HC-F7-F10	0.69 (17.5)	13/16	0.94 (23.9)
1/2	11/16	AL-HC-F8-F11	0.76 (19.3)	7/8	0.94 (23.9)
3/4	1	AL-HC-F12-F16	1.10 (27.9)	1 1/4	1.07 (27.2)

- Material : Aluminum
- Reusable

Hose Clamps

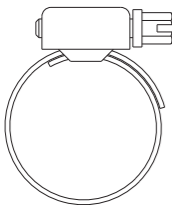

Min Hose OD	Max Hose OD	Ordering Number
mm	mm	
8	12	CP8-12
10	16	CP10-16
12	20	CP12-20
16	25	CP16-25
20	32	CP20-32
25	40	CP25-40

- Material : 304 SS
- Reusable

- Sizes and types listed are standard. Other sizes and types are available upon request, refer to the ordering information.
- All dimensions are for reference only and are subject to change. For dimensions not shown above, please contact the authorized representative or FITOK.

Ordering Information

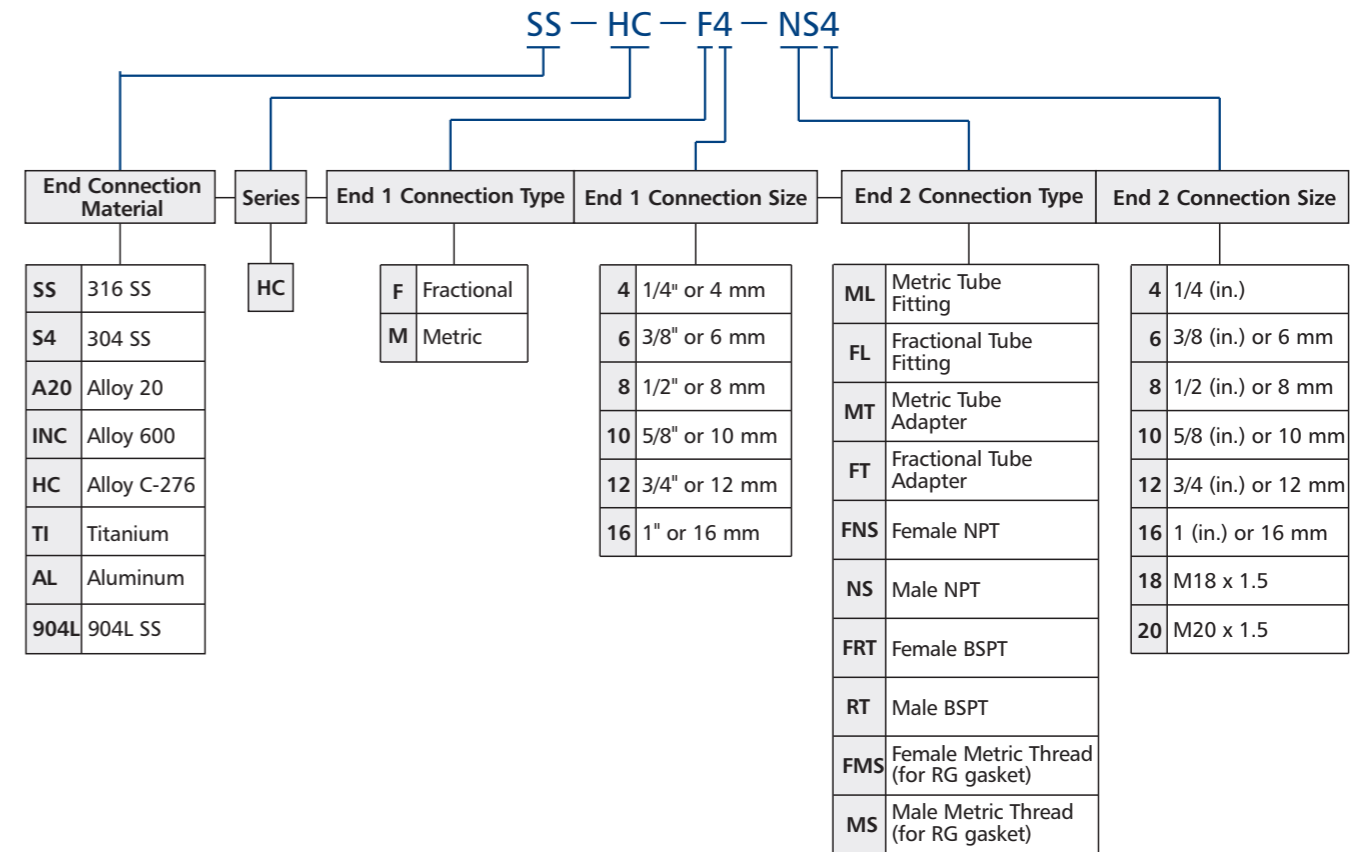

Example: SS-HC-F4-FT6

- SS: End connection material is 316 stainless steel.
- HC: HC series.
- F4: Hose ID is 1/4".
- FT6: End 2 connection type and size is 3/8" tube adapter.